

Step Ladder

Art. No.	A(mm)	B(mm)	C(mm)	D(mm)	E(-)
NH1721	330	210	Φ22	100	95

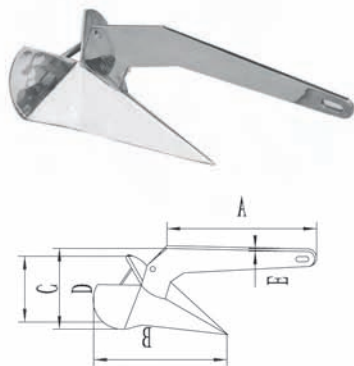

Stainless Steel And Carbon Steel Delta Anchor

Art. No.	A(mm)	B (mm)	C(mm)	D(mm)	E(mm)
NHSJM5KG	350	340	265	230	8
NHSJM7KG	520	400	275	270	10
NHSJM8KG	530	420	280	275	10
NHSJM10KG	570	450	290	280	10
NHSJM15KG	630	480	340	335	12
NHSJM16KG	640	500	350	340	12
NHSJM20KG	610	510	355	350	14
NHSJM25KG	480	520	400	360	16
NHSJM40KG	520	650	520	450	16

Sinzes:Be Made as Your Request



Carbon Steel And Stainless Steel Plough Anchor

Art. No.	A(mm)	B(mm)	C(mm)	D(mm)	E(mm)
NHLSM5KG	510	340	260	220	8~32
NHLSM7KG	560	380	270	230	8~32
NHLSM9KG	600	375	280	250	11~46
NHLSM10KG	620	400	290	270	11~46
NHLSM12KG	660	430	340	300	11~46
NHLSM15KG	730	490	370	330	13~50
NHLSM22KG	700	550	360	390	15~38
NHLSM27KG	780	600	460	360	15~40
NHLSM30KG	800	630	480	350	15~54

Garbon Steel And Stainless Steel Delfts Anchor

Art. No.	A(mm)	B(mm)	C(mm)	D(mm)	E(mm)
NHDFSM1.5KG	300		225	420	
NHDFSM2.0KG	350		230	470	
NHDFSM3.6KG	380	85	280	530	8
NHDFSM5.5KG	485	85	340	590	8
NHDFSM7.0KG	510	90	300	650	8
NHDFSM9KG	530	90	400	650	10
NHDFSM10KG	580	100	350	770	10
NHDFSM12KG	600	100	450	850	10
NHDFSM15KG	650	110	425	900	12
NHDFSM17KG		120			12
NHDFSM20KG		120			12
NHDFSM30KG		150			12
NHDFSM42KG		160			12
NHDFSM75KG		200			20
NHDFSM91KG		260			20

Sizes:Be Made as Y our Request

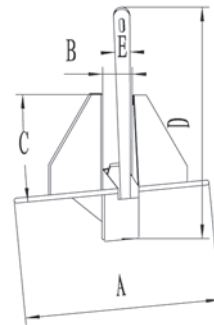

Garbon Steel And Stainless Steel Bruce Anchor

Art. No.	A(mm)	B(mm)	C(mm)	D(mm)	E(mm)
NHB1KG	265	110	183	130	8
NHB2KG	350	150	230	175	10
NHB2.5KG	400	160	220	200	15~18
NHB3.5KG	435	170	235	240	15~18
NHB5KG	470	190	310	270	15~18
NHB7.5KG	530	210	360	290	15~18
NHB10KG	600	228	380	320	15~18
NHB15KG	670	265	450	360	18~18
NHB20KG	715	360	470	390	15~20
NHB25KG	735	365	515	410	18~25
NHB30KG	815	425	550	460	18~25
NHB50KG	1000	440	675	500	18~30

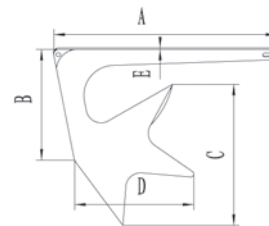

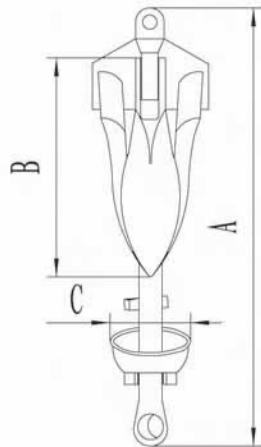

Stainless Steel Folding Anchor

Art. No.	A(mm)	B(mm)	C(mm)
NHZDM0.7KG	200	86	52
NHZDM1.5KG	305	135	53
NHZDM2.5KG	350	160	
NHZDM3.2KG	390	220	67
NHZDM4KG	432	240	76
NHZDM5KG	460	300	85
NHZDM7KG	530	300	85

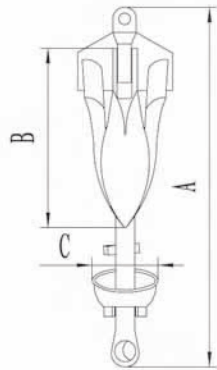

Hot Dipped Galvanized Folding Anchor

Art. No.	A(mm)	B(mm)	C(mm)
NHZDM0.7KG	200	120	52
NHZDM1.5KG	320	170	53
NHZDM2.5KG			
NHZDM3.2KG	420	220	67
NHZDM4KG	460	240	76
NHZDM6KG	540	300	85
NHZDM7KG	530	300	85
NHZDM8KG	650	612	135
NHZDM10KG			

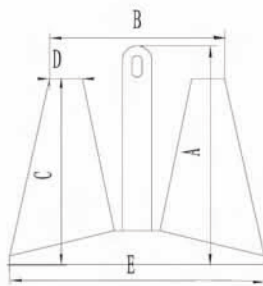

Anchor Filled With pb

Art. No.	A(mm)	B(mm)	C(mm)	D(mm)	E(mm)
NHGQM20KG	505	400	400	65	400
NHGQM25KG	505	400	400	65	400

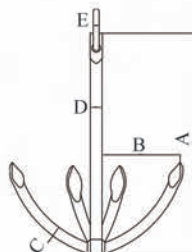

Anchor

Art.No.	A(mm)	B(mm)	C(mm)	D(mm)	E(mm)
NHSZM	590	200	Φ20	Φ25	Φ12